

CoaguChek[®] XS System

User Manual for Self-Testing



CoaguChek® XS System
User Manual for Self-Testing
Version 10.0

The contents of this manual, including all graphics and photographs, are the property of Roche Diagnostics. No part of this document may be reproduced or transmitted in any form or by any means, electronic or mechanical, for any purpose, without the express written permission of Roche Diagnostics.

Roche Diagnostics has made every reasonable effort to ensure that all the information contained in this manual is correct at the time of publication. However, Roche Diagnostics reserves the right to make any changes necessary without notice as part of ongoing product development.

Caution: Federal law restricts this device to sale by or on the order of a physician

This manual was created by the Roche Diagnostics Engineering Operations department. Direct questions or concerns regarding the contents of this document to:

Roche Diagnostics
Engineering Operations Department
9115 Hague Road
Indianapolis, IN 46256
USA

COAGUCHEK and SOFTCLIX are trademarks of Roche. All other trademarks are the property of their respective owners.

© 2007-2022, Roche Diagnostics.

US Order Number: 0 4999045001 (10) 2022-05 USA

Distribution in USA by: Roche Diagnostics, Indianapolis, IN

This document is available electronically at dialog.roche.com.

Manual version	Revision date	Changes
Version 2.0	November 2009	New document
Version 3.0	March 2011	Revised to update meter images, add disposal information and update product specifications section.
Version 4.0	September 2013	Revised error 6 and error 7 verbiage.
Version 5.0	April 2016	Revised to add Rx only statement.
Version 6.0	December 2016	Revised to add pictures of CoaguChek XS Softclix lancet device.
Version 7.0	June 2017	Revised to add information on display check; minor editorial revisions.
Version 8.0	February 2021	Added procedure on how to set the measuring unit to INR, removed bleach as recommended cleaning and disinfection solution, editorial revisions. This version is only available electronically.
Version 9.0	May 2021	Revised for software version 5.4x: measuring units %Q and Sec disabled and references to those units marked as applicable only for software versions 5.4 or lower.
Version 10.0	May 2022	Revised information on how to obtain a blood sample; enhanced troubleshooting section; minor editorial revisions.

Table of Contents

About this Manual	7
Symbols and Abbreviations	7
User Resources	8
Training DVD	8
Getting Started	8
User Manual	8
Test Strip Package Inserts	9
Lancet Device Package Inserts	9
The CoaguChek XS System	10
Anticoagulation Medication	10
Blood-clotting Time	10
How the System Works	11
The CoaguChek XS Meter	12
Operating Conditions	13
Getting Started	15
Batteries	15
Installing (or Replacing) Batteries	16
Meter Setup	17
Setting the date format	18
Setting the Date and Time	19
Setting the measuring unit to INR	22
Setting the beep tone	24
Setting the therapeutic range	25
The Meter's Display	29
Code Chip	30
Inserting a New Code Chip	31
Integrated Quality Controls	32

Testing a Blood Sample	33
Tips for a Good Fingerstick	33
Important Notes About Blood Testing.....	34
Always	34
Never	34
Infection Control.....	35
Preparing for a Test.....	36
Performing a Test.....	38
Very Low or Very High Test Results	46
Memory	49
Storing Test Results in Memory.....	49
Reviewing Stored Test Results	49
Erasing Stored Test Results.....	51
Cleaning/Disinfecting the Meter	53
Cleaning/Disinfecting the Exterior.....	54
Cleaning/Disinfecting the Test Strip Guide.....	55
Error Messages	59
Other Information	75
Product Limitations.....	75
Product Specifications.....	75
Operating Conditions	75
Sample material.....	76
Non-Operating Storage and Transport Conditions	76
Support/Services	76
Questions	76
Repairs	76
Display Information and Symbols	77
Disposal of the Meter, Test Strips, Lancets, and Batteries.	81
Warranty	83
CoaguChek XS Meter Limited (1 Year) Warranty	83

About this Manual

Symbols and Abbreviations

The test strip insert, the label on the back of the meter, the User Manual, and other packaging material may contain the following symbols or abbreviations:



Use by



Batch code/ Lot number



In vitro diagnostic medical device



Catalog number



Consult instructions for use



Caution, consult accompanying documents. Refer to safety-related notes in the manual accompanying this instrument.



Manufacturer



Date of manufacture



Temperature limitation (Store at)



The system fulfills the Canadian and U.S. safety requirements (UL LISTED, in accordance with UL 61010A-1:02 and CAN/CSA-C22.2 No. 61010-1-04)

Rx Only

Caution: Federal law restricts this device to sale by or on the order of a physician



Global Trade Item Number

User Resources

Several resources are available to help you use and maintain the CoaguChek XS System.

Training DVD

The CoaguChek XS System DVD is for new users of the CoaguChek XS System. This program will help you get comfortable with the CoaguChek XS Meter and the testing procedure.

Getting Started

The Getting Started guide shows you how to perform your first coagulation test on the CoaguChek XS Meter.

User Manual

This CoaguChek XS System User Manual is a comprehensive guide to the meter and test strips. It is designed to provide answers to your questions about the meter's operation and use. **Read this entire manual carefully, and refer to it as necessary.**

Test Strip Package Inserts

Be sure to read the test strip package insert for important updates and keep the insert from your current test strip package for future reference.

Lancet Device Package Inserts

Be sure to read the lancet device package insert to learn how to use the lancet device and for important updates. Keep the insert from your current lancet device package for future reference.

The CoaguChek XS System

The CoaguChek XS System measures blood-clotting time (Prothrombin Time) for people who are taking anticoagulation medications such as Coumadin® or warfarin. The CoaguChek XS System measures blood-clotting time using blood from the fingertip.

Anticoagulation Medication

Anticoagulation medications, also known as blood thinners, are prescribed to avoid unwanted clots. Your blood-clotting time must be monitored to ensure that your medication dosage is correct.

Blood-clotting Time

The rate at which blood clots is measured in units called INR. It is very important that you stay within your target INR range. If your INR is too low, the risk of blood clots increases. If your INR is too high, the risk for internal bleeding increases.

Everyone's INR is different. Your doctor determines the best INR range for you, depending on why you are taking anticoagulants and how you react to them. Your doctor also determines how often your blood should be tested. Your doctor needs to know your blood-clotting time in order to successfully treat you.

How the System Works

The CoaguChek XS System includes a meter and CoaguChek XS PT test strips. Each box of test strips has its own code chip that you insert into the meter. The code chip contains important information about the test strips such as their expiration date and lot number.

The display on the meter guides you through the testing process. With the code chip inserted in the meter, you simply insert a test strip and apply a blood sample when the meter is ready. The meter displays the result in about a minute. The meter automatically stores the result in memory so that you can easily recall results.

The CoaguChek XS PT test strip contains various ingredients. When a blood drop is applied, the meter starts the test and the blood mixes with the ingredients on the test strip. When the meter determines that the blood has clotted, it stops the measurement and calculates the result.

The CoaguChek XS Meter

- A** Display
- B** M (Memory) Button
- C** ON-OFF button
- D** Test Strip Guide Cover
- E** Test Strip Guide
- F** Battery Compartment Cover
- G** Code Chip Slot
- H** SET Button
- I** Data Port

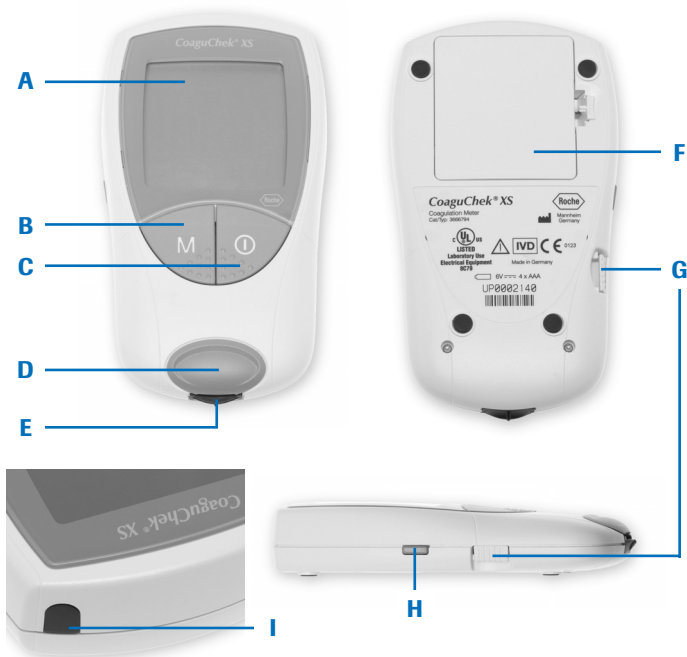

Operating Conditions

To ensure that the CoaguChek XS Meter functions correctly, follow these guidelines:

- Use the meter at room temperature, between 59°F and 90°F (15°C and 32°C).
- Use the meter at a relative humidity of less than 85%, without condensation.
- When testing, keep the meter level.
- If you store the meter for a period of time, remove the batteries.
- Do not use the meter at an altitude higher than 14,000 feet (4,300 meters).
- Do not use the meter near a strong magnetic field, such as a microwave oven, as this may interfere with the meter's proper operation.

Note: The CoaguChek XS Meter automatically shuts off after 3 minutes if no buttons have been pushed.

This page intentionally left blank.

Getting Started

Refer to the Getting Started guide to learn how to set up the meter and prepare for and run your first blood-clotting time test.

Batteries

The CoaguChek XS Meter uses 4 AAA batteries. The recommended batteries, alkaline-manganese batteries, should last for approximately 300 tests.

When you power the meter on, the display briefly shows the battery symbol. The battery symbol is divided into 4 segments. With new, fresh batteries in the meter, the battery symbol shows all 4 segments.



When only 1 segment appears, replace the batteries. When only 1 segment appears you can still access results stored in the meter's memory.



When replacing the batteries you must insert the new batteries within one minute of removing the old ones, to keep the date and time settings. If you take longer than this, you must re-enter the date and time. Refer to page 19.

The meter saves battery power by automatically powering off after 3 minutes, unless you press a button or insert a test strip. Even when the batteries are removed, the test results are saved in memory.

Installing (or Replacing) Batteries

Have ready 4 AAA alkaline batteries.

1. Open Battery Compartment

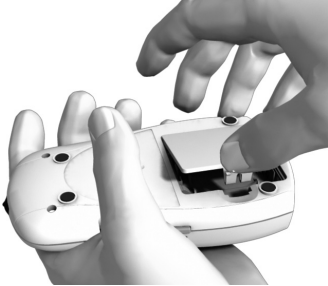

With the meter turned off, turn it over. Press the latch gently inward and lift the cover. Remove the old batteries, if necessary.

2. Insert New Batteries



Position the batteries according to the diagram inside the battery compartment. Replace the cover. Turn the meter back over.



If you have installed the batteries for the first time, the meter will start up in setup mode.

Meter Setup

When you turn the meter on, the display briefly shows the installed software version in the upper left corner of the display:

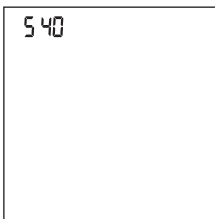

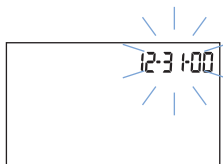

The CoaguChek XS Meter is preset with the U.S. date format (month-day-year) and U.S. time format (12-hour as opposed to 24-hour).

Setting the date format



In case meter has lost preset date format power the meter on by pressing the SET button  (**the entire date display flashes**).

Press the M button  until date format 12-31-00 flashes in the display.

Press the SET button  to save this setting and continue with the date setting. The display automatically moves on to the date setting.

Before you use the meter for the first time—or if there is no battery power for more than 1 minute—you'll have to set the current date and time.



Setting the Date and Time

The date and time settings are important. Each time you run a test, the meter compares its date with the test strip's expiration date. If the test strips are expired, the meter displays an error message and prevents you from running a test.

Note: If the date and time settings have not been set correctly, the meter may not detect that an expired test strip or an expired code chip is used.

Whenever you put batteries in the meter, it automatically goes to Setup mode (where you set the date and time). You can also go to Setup mode at any time by pressing the SET button (■).

To set the date and time, you'll use these buttons:

-  to change a setting.
-  (SET) to accept a setting.





1. Go to Setup Mode



If the meter is not already in Setup mode, press the SET button .



The date format flashes in the upper-right corner.

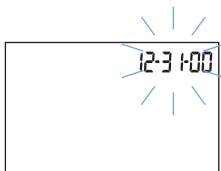

The date format can be changed by pressing the M button  until the desired format is reached. Confirm by pressing the SET button .

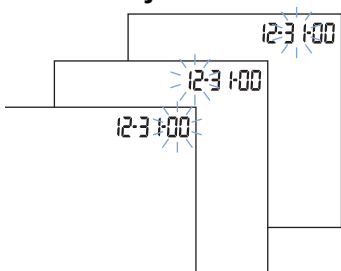



2. Set Today's Date



Press the M button  to change the year. Press the SET button .

Press the M button  to change the month. Press the SET button .

Press the M button  to change the day. Press the SET button .

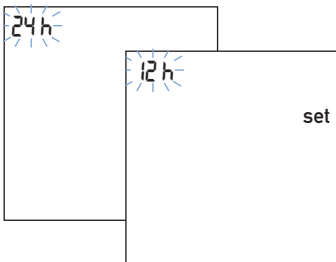



Now select the time format. You can choose between the 24-hour time format (presetting) and the 12-hour time format with “a.m.” or “p.m.”.

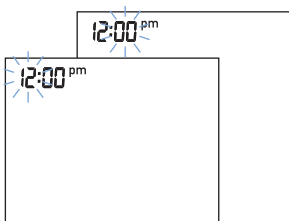

Press the M button  to toggle between 24-hour and 12-hour format.

Press the SET button  to save the correct setting. The display automatically moves on to the time setting.

3. Set Current Time



Press the M button  to change the hour. Press the SET button .

Press the M button  to change the minutes. Press the SET button .

Setting the measuring unit to INR

Please note: This procedure is only applicable for software versions 5.40 and lower. Refer to section Meter Setup above for information on how to retrieve the software version installed on your meter. For software versions from 5.4x on, INR is the only measuring unit option and cannot be changed.

In case the measuring unit next to the result is displayed in %Q or Sec, the unit has to be set back to INR unless your doctor has instructed you to measure in a unit other than INR (i.e. %Quick or Seconds):

4. Setting the measuring unit

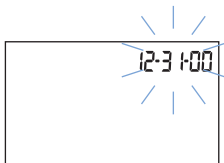



Press the SET button  on the left side of the meter to enter the Setup mode. First, the date format flashes in the upper-right corner.

Press the SET button  several times to confirm date, time format, and time already set in the meter.

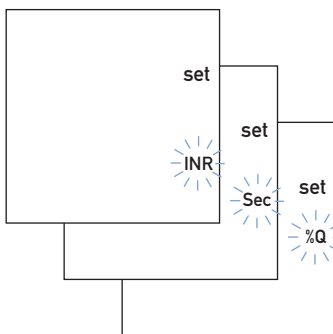
Press the SET button  again to display the actual measuring unit on the display.



Press the M button  until the measuring unit INR is flashing.

To save the measuring unit to INR, power off the meter by pressing the On/Off button. .

If you need assistance, call the Roche Customer Support Center at 1-800-428-4674.

Setting the beep tone

You can choose whether you want the beep tone “On” or “OFF”. If you have selected “On,” the meter will beep in the following situations:

- when it detects a test strip,
- when pre-heating of the test strip is complete and you need to apply a sample,
- when it detects a sample,
- when the result is displayed and
- if an error occurs (three short beeps).

We recommend you leave the beep tone turned on.

5. Setting the beep tone

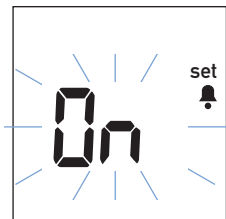

Press the M button  to toggle between “OFF” and “On” (“On” is the presetting).

Press the SET button  to save the chosen setting. The display automatically moves on to the next setting option.

Setting the therapeutic range

Within the next step, you have the option to set your therapeutic range prescribed by your doctor. If you switch this display option to “ON”, an up or down arrow displays whenever the result is above or below the target range you have set. This highlights the fact that the result is outside your target range.

Consult your doctor about what target range is appropriate for you.

If you selected “OFF”, the settings are now complete, and “End” appears in the display (see page 27).

6. Setting the therapeutic range

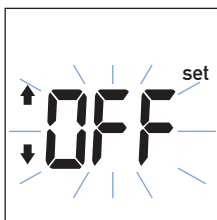



Press the M button  to toggle between “OFF” and “On”.

Press the SET button  to save the chosen setting and continue with the meter setup.

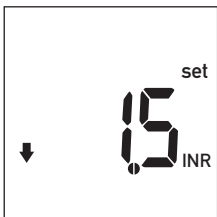
If you have activated this display option (“On”), you are now able to enter the limits of your target range.



Press the M button  to set the **lower** limit (symbolized by the down arrow) within the range 1.5 – 3.5 INR.

Press the SET button  to save the chosen lower limit and continue with the upper limit setting.

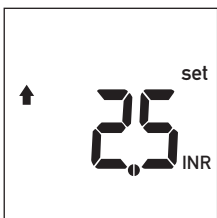

Now press the M button  to set the **upper** limit (symbolized by the up arrow) within the range 2.5 – 4.5 INR. The selectable range will be at least 0.1 INR above the lower limit you have selected.

Press the SET button  to save the chosen upper limit and close the meter setup.

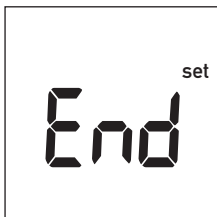

The meter setup is now complete. This display screen appears automatically after you have completed the last setting and remains for a few seconds to indicate that the setup procedure is now complete.

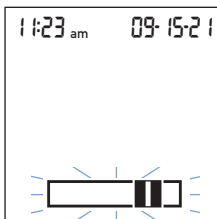



After that the meter automatically enters Test Mode.

7. Power Off



Power the meter off  .

If, in the future, you need to change the date and time, press the SET button  to re-enter Setup mode. After you have changed the date and time, just turn the meter off  . Other set-up choices in the meter should be set or changed by your doctor.

The following is only applicable for software versions 5.40 and lower.

Ensure with the next test result that the measuring unit is displayed as INR. If the result is displayed in %Q or Sec, follow the instructions in the *Testing a Blood Sample* section of this manual to reset the measuring unit to INR.

The Meter's Display

The meter performs an automatic display check when it is turned on. In case you suspect the display or parts of it to be defective (e. g. if you have dropped the meter), you must check by means of the display test if the meter display works properly. If your display is not functioning properly, do not perform further tests as results may be misread if a segment is missing. Contact the Roche Customer Support Center at 1-800-428-4674 in this case.

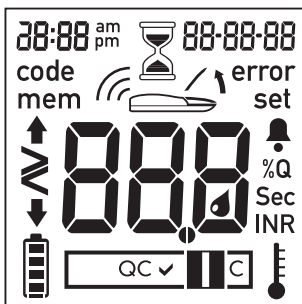

If the display check is too quick, you can put it “on hold” by pressing and holding down the On/Off button  the next time you turn the meter on. For as long as you keep the button pressed, the display remains frozen.

The full display should appear as shown at left.

Code Chip

Each box of test strips comes with its own code chip. The code chip provides the meter with information such as the lot number and expiration date of the test strips.

Before each test, make sure the correct code chip is in the meter. Each time you open a new box of test strips, replace the old code chip with the new one.

Caution: Using the wrong code chip can produce incorrect results.

Protect the code chip from moisture and also from equipment that produces magnetic fields, such as a microwave oven.

Inserting a New Code Chip

Have the correct code chip ready.

1. Remove Old Code Chip

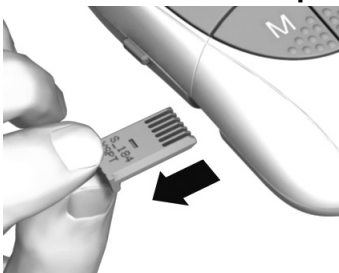

With the meter turned off, remove the old code chip and throw it away.

2. Match Codes

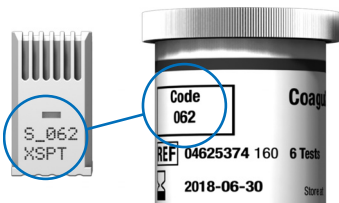

Make sure that the 3-digit code number on the new test strip container matches the 3-digit code number on the new code chip.

3. Insert New Code Chip

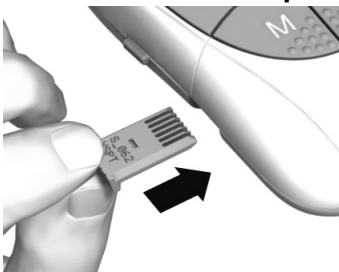

Slide the new code chip into the code chip slot until it snaps into place.

Integrated Quality Controls

The CoaguChek XS System has built-in quality control functions in the meter and test strips. The meter automatically runs its own quality control test as part of every blood test, so you never have to run quality control tests with liquid quality controls.

When the quality control test runs, the letters **QC** flash on the meter's display. When the quality control test is finished, a checkmark (✓) appears following the letters **QC**. Then the meter continues to run the blood test.

If the quality control test fails, the meter displays this error message. See the *Error Messages* section in this manual for an explanation of this and other error messages and what to do when they occur.

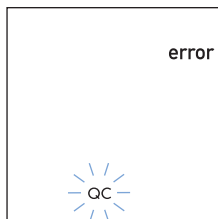

Testing a Blood Sample

Tips for a Good Fingertick

For fingertick blood testing, increasing the blood flow in the finger will help you get a good drop of blood. Before you stick your finger, try the following techniques until you see that your fingertip has good color:

- Warm your hand by holding it under your arm, use a hand warmer, and/or wash your hand with warm water.
- Hold your arm down by your side, so that your hand is below your waist.
- Massage your finger from its base.



If needed, immediately after lancing, gently massage your finger from its base until a drop of blood is formed. Do not press or squeeze the finger.

Important Notes About Blood Testing

Always

- Always operate the meter at temperatures between 59°F and 90°F (15°C and 32°C).
- Always refer to the test strip package insert for proper use and handling of test strips.
- Always keep the test strip guide and meter clean. See *Cleaning/Disinfecting the Meter* section in this manual for more information.

Never

- Never store the meter in extreme temperatures below 59°F or above 90°F (below 15°C or above 32°C).
- Never store the meter in damp or humid conditions (greater than 85% humidity).
- Never remove or insert the code chip while the meter is performing a test.
- Never use a code chip from a box of test strips other than the one in use.
- Never touch or remove the test strip during a test.
- Never wait more than 15 seconds after sticking your fingertip before applying the blood.

- Never add more blood after the test has begun.
- Never touch any buttons while a test is in progress.
- Never perform a test with a drop of blood from a previous fingerstick.

Infection Control

The CoaguChek XS Softclix lancet device is intended for use by a single person and is not suitable for use where testing different persons with the same device may lead to infections.

Preparing for a Test

1. Gather Items



Gather the following items:

- CoaguChek XS Meter
- Container of test strips
- Test strip code chip
- CoaguChek XS Softclix lancet device and lancet

Each box of test strips comes with a matching code chip. Every time you open a new box of test strips, you must replace the code chip.

2. Match Codes

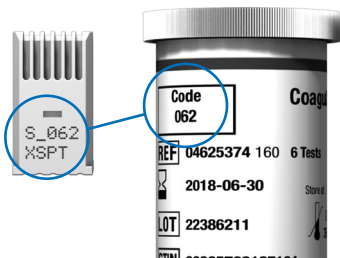

Make sure the 3-digit code number on the test strip container and the code chip match.

3. Insert Code Chip

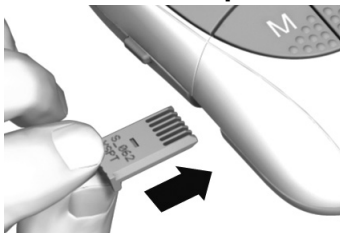

Make sure the meter is turned off. With the code number facing up, insert the code chip into the code chip slot until it snaps into place.



Pull off the cap of the lancet device. Insert a new lancet. Twist off the lancet's protective cap. Put the cap back on the lancet device. Line up the notches for the cap to fit. Select the penetration depth. Press the plunger. A yellow dot appears in the release button.

4. Wash Hands



Wash your hands in warm, soapy water.

Make sure your fingertip is thoroughly dry.

Performing a Test

1. Get Ready



Take a test strip out of the container.

Close the container tightly.

You have 10 minutes to use a test strip once you remove it from the container.

2. Insert Strip

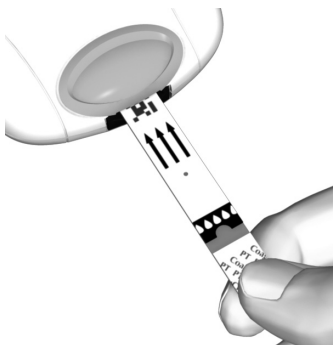

Slide the test strip into the test strip guide in the direction of the arrows until it stops.

☑ *The meter turns on. The code number of the inserted code chip flashes on the display.*

3. Match the Code Numbers



Confirm that the number displayed matches the number on the test strip container, then press the M button .

If the numbers are different, make sure you are using the code chip that came with the test strips you are using.

4. Warming up the Test Strip

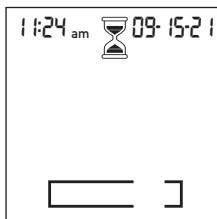

The hourglass symbol shows that the test strip is warming up for about 30 seconds. When the warming-up process is complete, a beep tone (provided the beep tone is turned on) indicates that you can now apply blood.

5. Sample Application

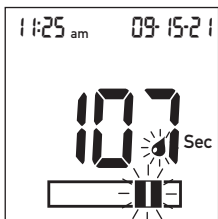

The blood drop symbol and the application area flash to indicate that the meter is ready to perform the test and is waiting for blood to be applied.

At the same time a 180-second countdown begins. You must apply the drop of blood to the test strip within this time, otherwise you will receive an error message (**error**, and “**000**” where the result would normally be displayed).

6. Collect the Blood

Massage your finger until you see increased color in your fingertip.



Keeping your hand down, press the tip of the lancet firmly against the side of your fingertip. Press the release button.

Gently massage your finger from its base until a drop of blood is formed. Do not press or squeeze the finger.

7. Identify the Target Area

Find the target area on the test strip.



To prevent error messages, the meter must be on a table free of vibrations.

8. Apply the Blood

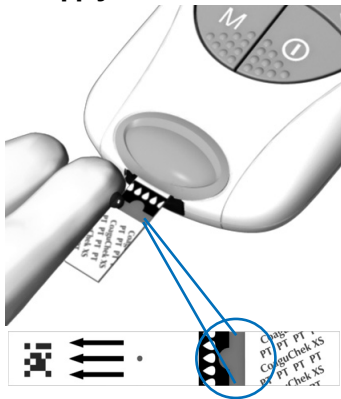

After sticking your fingertip, you have 15 seconds to apply one drop of blood to the top or side of the clear target area of the test strip.

☑ *Hold the blood drop to the test strip until you hear a beep. The flashing blood drop symbol disappears.*

Do not add more blood to the test strip. Do not touch the test strip.

☑ *The result appears in about 1 minute.*

9. Check the Result

Confirm that the result is displayed in INR.

The measuring unit is displayed next to the result.

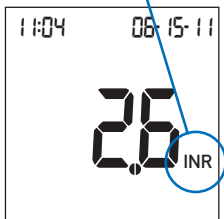

Only applicable for software versions 5.40 or lower:

You must confirm that the measured result is displayed in INR prior to using the result and whenever the date and time settings were modified unless your doctor has instructed you to measure in a unit other than INR (i.e. %Q or Sec).

If the result is displayed in %Q or Sec, follow the instructions in the procedure *Setting the measuring unit to INR* of this section to reset the measuring unit to INR.

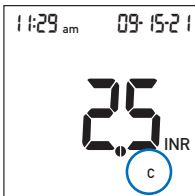

If a “c” is displayed along with the result, the hematocrit value might be very low or the blood sample might not have been collected properly (e.g., wet hands). Repeat the measurement and make sure that the patient’s hands are dry. If the message persists, perform a hematocrit check.

10. Record Result

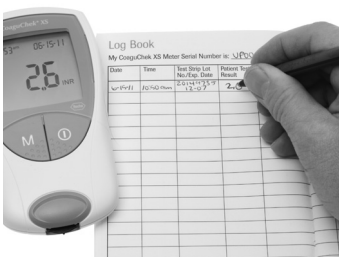

Record the INR result on the *CoaguChek XS System Prothrombin Time Self-Testing Log Book*.

Call your doctor and/or the service provider that provides your test strips and the handling of your test results.

11. Clean Up



Remove the lancet from the lancet device. Place the used test strip and lancet in a puncture-proof container with a lid. Turn the meter off  .

If the meter is dirty, wipe it clean with a lint-free tissue and an approved cleaning solution. See [Cleaning/Disinfecting the Meter](#) section of this manual.

Very Low or Very High Test Results

The CoaguChek XS PT test strips provide test results in the measuring range of 0.8 to 8.0 INR. If the meter displays < (less than) 0.8 INR or > (greater than) 8.0 INR, repeat the test. If, when you repeat the test, you get the same result (either <0.8 INR or >8.0 INR), call your doctor, as the result is out of the measuring range of the meter.

Only for software versions 5.40 and lower:

If the result is displayed in %Q or Sec, follow the instructions in the procedure *Setting the measuring unit to INR* (page 22) or call the Roche Customer Support Center at 1-800-428-4674 to reset the measuring unit to INR. If the measuring unit is set correctly to INR, repeat the test.

If, when you repeat the test, you get the same result (either < 0.8 INR or > 8.0 INR), call your doctor.

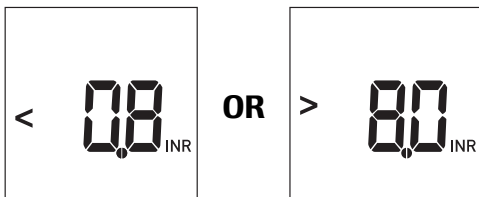

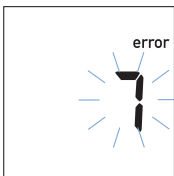

If you see “error 7,” this means the meter was unable to detect a clot. Repeat the test. Be sure to carefully follow the steps on the previous pages. For example, make sure the fingertip is thoroughly dry, use the meter on a surface free of vibrations, and **apply the blood drop within 15 seconds of sticking the fingertip**. If you still get “error 7,” call your doctor immediately to arrange for testing using another method.



For meters with serial number UP0910000 and lower: In rare cases, “error 6” may indicate extremely high coagulation times (> 10 INR). If “error 6” is displayed repeatedly, please contact your doctor without delay.

This page intentionally left blank.

Memory

Storing Test Results in Memory

The CoaguChek XS Meter automatically stores up to 300 test results and their dates and times in its memory. If the memory is full when you perform a test, the oldest result is automatically deleted. The most recent result is always saved.

Note: All test results remain in memory even when the meter is without batteries.

Reviewing Stored Test Results

You can review stored test results even when the meter's battery power is low. To review results in memory:

1. Access the Memory

Press the M button .

The meter turns on, if it is not already on, and goes to Memory mode.



2. View Most Recent Result



The most recent test result appears. The letters **mem** indicate that you are viewing a result in memory. The time and date of the test also appear.

If there are no results in memory, a **0** appears in the display's top-right corner.

3. View Earlier Results



To view earlier results, press the M button  again.

After you have viewed all the results in the memory, 3 dashes appear.



Erasing Stored Test Results

You can erase all of the test results that are stored in the meter's memory. You cannot, however, erase individual test results.

To erase all stored results:

1. Go to Erase mode



With the meter turned off, press **and hold down** the M button . While you are holding down the M button, press the ON-OFF button  and then hold down both buttons for at least 5 seconds.

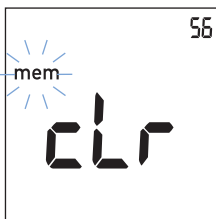

The meter displays **mem** (flashing) and **clr**. The number of results in memory is shown in the top-right corner of the display.

2. Confirm



Press the M button  to confirm that you want to erase the entire memory.

The hourglass symbol flashes while the test results are being erased.

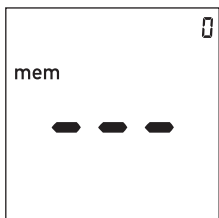

Then, the counter is set to **0** and 3 dashes appear.

Note: To exit Erase mode without erasing the results, press the ON-OFF button instead.

Cleaning/Disinfecting the Meter

Please follow the procedures below to clean and disinfect the meter. Failure to follow these procedures may cause malfunction of the meter.

- Clean the meter only when contaminated with blood.
- Do not use sprays of any sort.
- Ensure that swab or cloth is only damp, not wet.

Useful tip: To prevent contamination, apply blood via side-dosing directly from fingertip.

Cleaning/Disinfecting the Exterior

- Use 70% isopropyl alcohol (rubbing alcohol) to clean and disinfect the meter housing (the exterior of the meter).
- Ensure that the blue test strip guide cover remains tightly closed while cleaning the housing.

1. Clean/Disinfect the Exterior



With the meter powered off, wipe the meter's exterior clean.

- Do not let liquid accumulate near any opening. Make sure that no liquid enters the meter.

2. Dry the Exterior

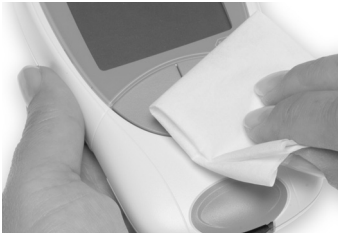

- With a lint-free tissue, wipe away residual moisture and fluids after cleaning the housing.
 - Allow wiped areas to dry for at least 10 minutes before performing a test.
-

Cleaning/Disinfecting the Test Strip Guide

- Use 70% isopropyl alcohol (rubbing alcohol) to clean the test strip guide.

1. Open the Cover



With the meter turned off, use your thumbnail to open the cover of the test strip guide by pressing its front edge upward.

2. Clean/Disinfect the Test Strip Guide

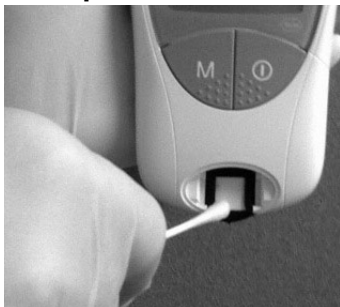

- Hold the meter upright with the test strip guide facing down.
- Clean the easily accessible areas with a cotton swab.
- Be sure the swab is only damp, not soaking wet, to ensure excess fluid does not enter the meter.
- Wipe away residual moisture and fluids.

Caution: Do not insert any objects into the test strip guide. Doing so could damage the electrical contacts behind the test strip guide.

3. Allow to Dry



With the cover off, allow the test strip guide to dry for at least 10 minutes before re-attaching the test strip guide cover and testing again.

4. Close the Cover



Close the cover, and make sure it snaps into place.

This page intentionally left blank.

Error Messages

You may see the following error messages while using the CoaguChek XS Meter. If you see an error message, first try to correct the problem using the solution described below. If the problem persists, call the Roche Customer Support Center at 1-800-428-4674, Monday through Friday from 7 AM to 11 PM EST.

In case of an emergency, please contact your doctor.

Flashing default date

The meter is missing or has lost date and time information (e.g., after turning on for the first time or because the batteries were removed from the meter for more than one minute). You cannot perform a test.

Solution:

See the chapter *Setting the Date and Time* starting on page 19 (and *Setting the date format* on page 18) to set up date and time correctly.

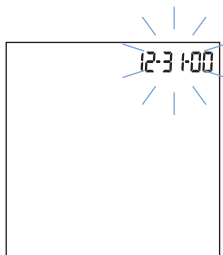

Error: Test Strip

Possible causes:

- A test strip was already inserted when the meter was turned on.
- The meter timed out after you inserted the test strip.
- The test strip is unusable.
- The test strip is not a CoaguChek XS PT test strip.

Solution:

Remove the test strip.
Then repeat the test with a new CoaguChek XS PT test strip.

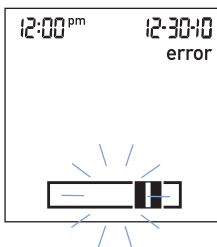

Error: Meter Ambient Temperature

The meter is too cold or too warm to measure correctly.

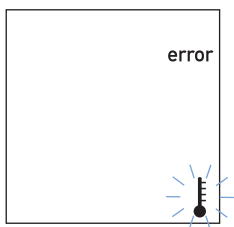

Solution:

Turn the meter off and allow it to stand for about 30 minutes at room temperature between 59°F and 90°F (15°C and 32°C).

Notice

If the code chip of a liquid quality control solution (number starting with “C_...”, **not** a regular consumable for this meter) has inadvertently been inserted, the “Meter Temperature” error may also be displayed. In this case:

- Remove the wrong code chip and the batteries.
- Reinsert the batteries after no less than 5 minutes.
- Set date and time correctly after inserting the batteries (see the chapter *Setting the Date and Time* starting on page 19 to set up date and time correctly).

Error: Battery

The battery level is too low. You cannot perform a test.

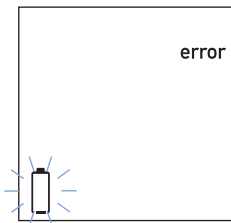

Solution:

Insert new batteries as described in the *Installing (or Replacing) Batteries* section of this manual.

If the meter has lost date and time information after replacing the batteries, see the chapter *Setting the Date and Time* starting on page 19 to set up date and time correctly.

Error: Test Strip Guide Cover

The test strip guide cover is not properly closed.

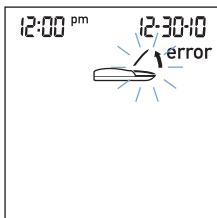

Solution:

Close the test strip guide cover.

Error: Code Chip

The code chip is missing, not properly inserted, or damaged.

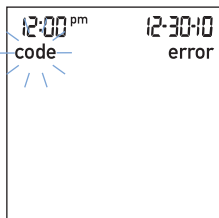

Solution:

Check to see if you have the correct code chip properly inserted into the meter. For more information, see the *Code Chip* section of this manual.

If the code chip is damaged, call the Roche Customer Support Center at 1-800-428-4674.

Error: Test Strip Expired Solution:

The inserted code chip and the corresponding test strip are beyond the expiry date.

Always confirm that the inserted code chip matches the number on the label of the test strip container in use (see page 31).

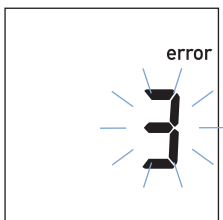

- Check whether the date setting is correct in the meter. If it is not, set the correct date (see the chapter *Setting the Date and Time* starting on page 19 to set up date and time correctly).
- Check whether the number of the inserted code chip matches the number on the test strip container currently in use. If it does not, insert the correct code chip belonging to this (not expired) test strip lot.
- **If the error persists, turn the meter off, remove the code chip and test strip. Use a test strip from a new lot and insert the code chip that came with the new lot. Ensure you are not using expired test strips.**

Error: Test Strip or Meter

The test strip is unusable or the sample has been applied too early (before the 180 seconds countdown begins).

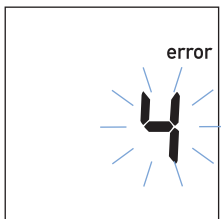

Solution:

Power the meter off and use a new test strip. Wait until the hourglass symbol disappears and the countdown for sample application is shown.

If you still get the error message after you have inserted a new test strip, call Roche Customer Support Center at 1-800-428-4674.

Error: Time Exceeded

You did not apply blood to the test strip within 180 seconds after the blood drop symbol appeared.

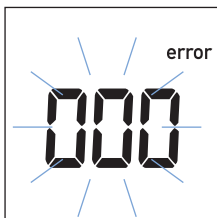
**Solution:**

Turn the meter off and remove the test strip. Repeat the test using a new test strip and blood taken from a new fingerstick from a different finger.

Error: Blood Application Solution:

Error applying blood to the test strip or blood sample size was too small.

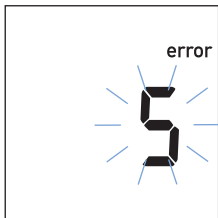

Turn the meter off and remove the test strip.

Re-read the instructions about applying blood (starting on page 33). Repeat the test with a new test strip and **a sufficient amount of blood** from a different finger.

If you still get the error message, call Roche Customer Support Center at 1-800-428-4674.

Error: Test Strip Interference

The test strip was touched or removed during the test.

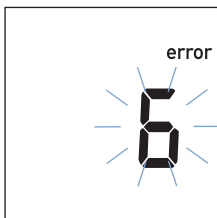

Solution:

Turn the meter off and remove the test strip. Repeat the test using a new test strip and blood taken from a new fingerstick from a different finger.

Do not touch or remove the test strip when a test is in progress.



For meters with serial number UP0910000 and lower: In rare cases, “error 6” may indicate extremely high coagulation times (> 10 INR). If “error 6” is displayed repeatedly, please contact your doctor without delay.

Notice

This error (6) might also be triggered by high hematocrit values (above 55 %), or the blood containing a high concentration of oxidizing substances, e.g. after a Vitamin C infusion.

Error: Internal Quality Control Failure

The test strip failed the internal quality control check. The test strip is unusable.

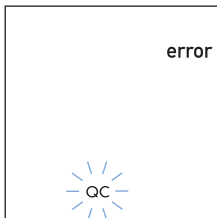

Solution:

Turn the meter off and remove the test strip. Repeat the test using a new test strip and blood taken from a new fingerstick from a different finger.

Notice

After removing a test strip from its container, always make sure to **immediately close the container again** with the stopper. Exposure to external influences (e.g. humidity or ambient light) may deteriorate the test strips. The blue reagent line on the back of the strip may turn pink or purple if the strips have been exposed to external influences.

Error: Sample Error

Measurement error caused by the blood sample.

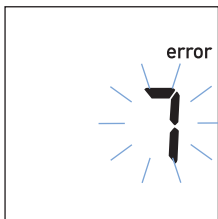

Solution:

If you see “error 7,” this means the meter was unable to detect a clot. Repeat the test. Be sure to carefully follow the steps on the previous pages. For example, make sure the fingertip is thoroughly dry, use the meter on a surface free of vibrations, and apply the blood drop within 15 seconds of sticking the fingertip. If you still get “error 7,” call your doctor immediately to arrange for testing using another method.

 This error message (7) can occur in rare cases, i.e. in patients with unusually long coagulation times (> 10 INR). If this error message appears again when the test is repeated, it's urgent to contact a doctor immediately and seek an alternate method of testing!

Error: Internal Error

An error occurred during the internal diagnostic test.

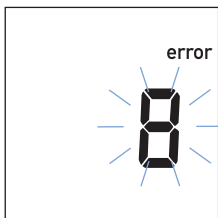

Solution:

Turn the meter off and remove the batteries. Wait at least one minute before inserting the batteries into the battery compartment. Re-set the date and time if necessary as described in the *Meter Setup* section of this manual.

In case the error persists, the charging capacity of the batteries might be too low to finalize the measurement. Replace all four batteries with brand new AAA alkaline batteries. Repeat the test after checking date and time.

Caution: The date and time must be set correctly.

If you see the same error message again, the meter has a defect, or the maximum number of test strip insertions might be reached. Call Roche Customer Support Center at 1-800-428-4674.

Error: Internal Error

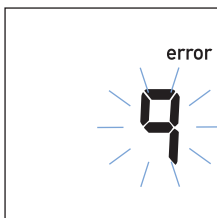

Solution:

Because this error indicates possible damage to the heater plate contacts, call the Roche Customer Support Center at 1-800-428-4674 to have the meter replaced.

This page intentionally left blank.

Other Information

Product Limitations

Please read the information packaged with the test strips regarding up-to-date product specifications and limitations.

Product Specifications

Operating Conditions

Temperature	59°F to 90°F (15°C to 32°C)
Relative humidity	Less than 85% (without condensation)
Maximum altitude	14,000 feet (4300 m)
Placement	Operate the meter on a level, vibration-free surface or hold it so it is roughly horizontal.
Measuring range	Refer to test strip package insert.
Memory	300 test results with date and time
Interface	Infrared interface, LED/IRED Class 1
Battery operation	4 AAA alkaline batteries
Number of tests per set of batteries	Up to 2 years or up to 300 tests (depending on frequency of use)
Safety class	III
Automatic power-off	After 3 minutes
Dimensions	5.43 x 3.07 x 1.10 in (138 x 78 x 28 mm)
Weight	4.48 oz. or 127 g (without batteries)

Sample material

Sample type	Capillary whole blood or non-anticoagulated, venous whole blood.
Sample size	At least 8 μ L
Interactions	Refer to the test strip package insert.

Non-Operating Storage and Transport Conditions

Temperature range	-13°F to 158°F (-25°C to 70°C)
Relative humidity	10% to 85% (without condensation)

Support/Services

Questions

Please call the Roche Customer Support Center at 1-800-428-4674 (Monday through Friday from 7 AM to 11 PM EST) if you have questions regarding the handling of your meter, the reliability of your results, or if you suspect the meter is defective.

In case of an emergency, please contact your physician.

Repairs

Please note that repairs, new settings or other modifications to the meter may only be performed by persons authorized by Roche Diagnostics.

Display Information and Symbols



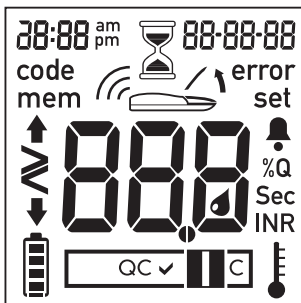

The meter performs an automatic display check when it is turned on. In case you suspect the display or parts of it to be defective (e. g. if you have dropped the meter), you must check by means of the display test if the meter display works properly. If your display is not functioning properly, do not perform further tests as results may be misread if a segment is missing. Contact the Roche Customer Support Center at 1-800-428-4674 in this case.

If the display check is too quick, you can put it “on hold” by pressing and holding down the On/Off button  the next time you turn the meter on. For as long as you keep the button pressed, the display remains frozen.



















The full display should appear as shown at left.

These symbols may appear on the display. They have the meanings shown:

Symbol	Meaning
	Test strip (without sample application area)
	Test strip (with sample application area)
	Apply sample
	User must wait until the meter has completed an action.
24 h	24-hour time format
12 h	12-hour time format
am	Time between midnight and noon (in 12-hour time format)
pm	Time between noon and midnight (in 12-hour time format)
%Q	Indicates the results are displayed as a Quick percentage value.*
Sec	Indicates the results are displayed in Seconds.*
INR	Indicates the results are displayed in INR units.

* Only available for SW version 5.40 and lower.

Symbol	Meaning
	Beep tone is enabled
	Beep tone is disabled
	Result is above the chosen therapeutic range (only with INR as unit)
	Result is below the chosen therapeutic range (only with INR as unit)
	<ul style="list-style-type: none"> Results in the chosen unit Error numbers
	Memory contains no results or no further results
	Displays the time in HH:MM format
	Displays the date in DD-MM-YY, MM-DD-YY or YY-MM-DD format.
	The monitor is in Setup Mode.
	Indicates the code number of the code chip inserted in the meter.
	Result in the chosen unit is above the measuring range.
	Result in the chosen unit is below the measuring range.

Symbol	Meaning
	<p>Battery status:</p> <ul style="list-style-type: none"> ▪ When the batteries still have their full charge, all segments are lit. ▪ Individual segments disappear one by one as the batteries become weaker. ▪ When there is no segment remaining, you can no longer perform a test. You can, however, still access the meter's memory.
<p>mem</p>	<p>The meter is in Memory Mode.</p>
	<p>Automatic quality control completed successfully</p>
<p>error</p>	<p>Reports an error (see Error messages)</p>
	<p>Room or meter temperature is outside the acceptable range.</p>
	<p>Communication is taking place via the infrared interface</p>
	<p>Measurement chamber cover is open.</p>

Disposal of the Meter, Test Strips, Lancets, and Batteries



Any product coming in contact with blood is considered contaminated (potentially infectious).^{*} During normal testing, the meter may come in contact with blood. Lancing devices may also be considered sharps. Disposal of sharps is regulated by law in many jurisdictions.

The European Union has a requirement for improving waste management practices for certain electronic equipment, but meters fall outside the scope of the European Directive 2002/96/EC.^{**} This is not a requirement for the United States; however, Roche is committed to recycling and sustainability. Please consider the following points when disposing of your used testing materials:

^{*}29 CFR 1910.1030 - Bloodborne pathogens

^{**}Directive 2002/96/EC - Directive on waste electrical and electronic equipment (WEEE)

- Comply with any laws or ordinances relating to the disposal of sharps and/or contaminated products. Contact your local health department or other appropriate authorities for proper handling and disposal of used meters, used test strips, used lancets, and used batteries.
- Consider recycling of the meters and batteries at an appropriate facility. Be aware the meter is potentially hazardous electronics scrap (e-scrap) and should be disposed of accordingly. The batteries are potentially hazardous also and should be disposed of accordingly.
- Decontaminate the meter before recycling or disposing. Wipe the outside of the meter with dilution of bleach solution (one part bleach to nine parts water).
- Users in professional environments (i.e., healthcare professionals) should follow the existing policies and procedures governing the proper handling and disposal of potentially infectious waste, e-scrap and batteries.

Warranty

CoaguChek XS Meter Limited (1 Year) Warranty

ROCHE DIAGNOSTICS warrants, to the original purchaser only, that the meter shall be free from all defects in material and workmanship for a period of one (1) year from the date of purchase.

Purchaser's sole and exclusive remedy, with respect to the CoaguChek XS meter and parts thereof, shall be the repair and/or replacement of the meter or parts at the option of Roche Diagnostics.

THE ABOVE WARRANTY IS EXCLUSIVE OF ALL OTHER WARRANTIES, AND ROCHE DIAGNOSTICS MAKES NO OTHER WARRANTIES, EXPRESS OR IMPLIED, INCLUDING WITHOUT LIMITATION THE IMPLIED WARRANTY OF MERCHANTABILITY OR FITNESS FOR A PARTICULAR PURPOSE. IN NO EVENT SHALL ROCHE DIAGNOSTICS BE LIABLE TO THE PURCHASER OR ANY OTHER PERSON FOR ANY INCIDENTAL, CONSEQUENTIAL, INDIRECT, SPECIAL OR PUNITIVE DAMAGES ARISING FROM OR IN ANY WAY CONNECTED WITH THE PURCHASE OR USE OF THE METER. NO WARRANTY OF MERCHANTABILITY OR FITNESS FOR A PARTICULAR PURPOSE, IF ANY, IS IMPLIED FROM THE SALE OF THE COAGUCHEK XS METER. NO WARRANTY, EXPRESS OR IMPLIED (IF ANY), SHALL EXTEND FOR A LONGER DURATION THAN THE DURATION OF THE EXPRESS WARRANTY STATED ABOVE.

The foregoing warranty shall not apply to a meter which is damaged by accident or subject to alteration, misuse, tampering, and/or abuse, including but not limited to cleaning or disinfecting the meter with any product other than products approved for such purpose in the Operator's Manual. Meters which show damage or misuse will be handled in accordance with the non-warranty service policy of Roche Diagnostics.

The warranty of the repaired/replacement meter will expire on the date of the original warranty expiration or ninety (90) days after shipment of a replacement system, whichever period is longer.

Notes:

Notes:

COAGUCHEK and SOFTCLIX
are trademarks of Roche.



Roche Diagnostics GmbH
Sandhofer Strasse 116
68305 Mannheim, Germany

Made in Germany

Manufactured for and distributed in the U.S.A. by:
Roche Diagnostics
9115 Hague Road
Indianapolis, IN 46256

Rx Only

www.roche.com
<https://go.roche.com/CoaguChekXS-USA>
dialog.roche.com